

Varenummer: 0102225  
 Beskrivelse: Seeger låsering J 470 DIN 472  
 Fjederstål

## Mål

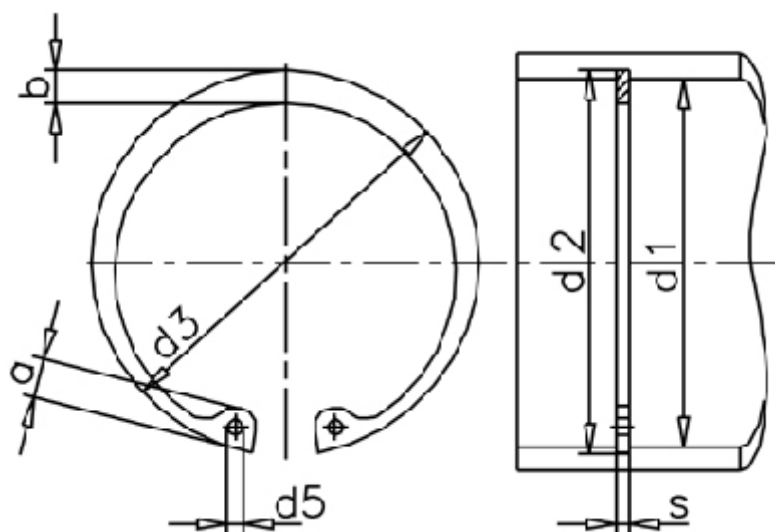

a max	= -	FN kN	= 1495.00	t	= 6.00
AN mm <sup>2</sup>	= 8973.0	FRg kN	= 132.0	Tang	= ZGJ-5
b	= 26.0	FR kN	= 1330.0	tol	= -0.15
Betegnelse	= J 470	g	= 6.0	tol	= +2,00-1,00
d1	= 470	K kN-mm	= 3048.0	tol	= +1,00
d2	= 482.0	m min	= 7.20	vægt kg/1000	= 1595.00
d3	= 490.00	Nominel træk	= 18.0		
d5 min	= 6.0	s	= 7.00		